

array
converter

Advanced Interfaces for Utility Scale PV

ARPA-E Workshop

February 2011

Imagine an AC-PV World

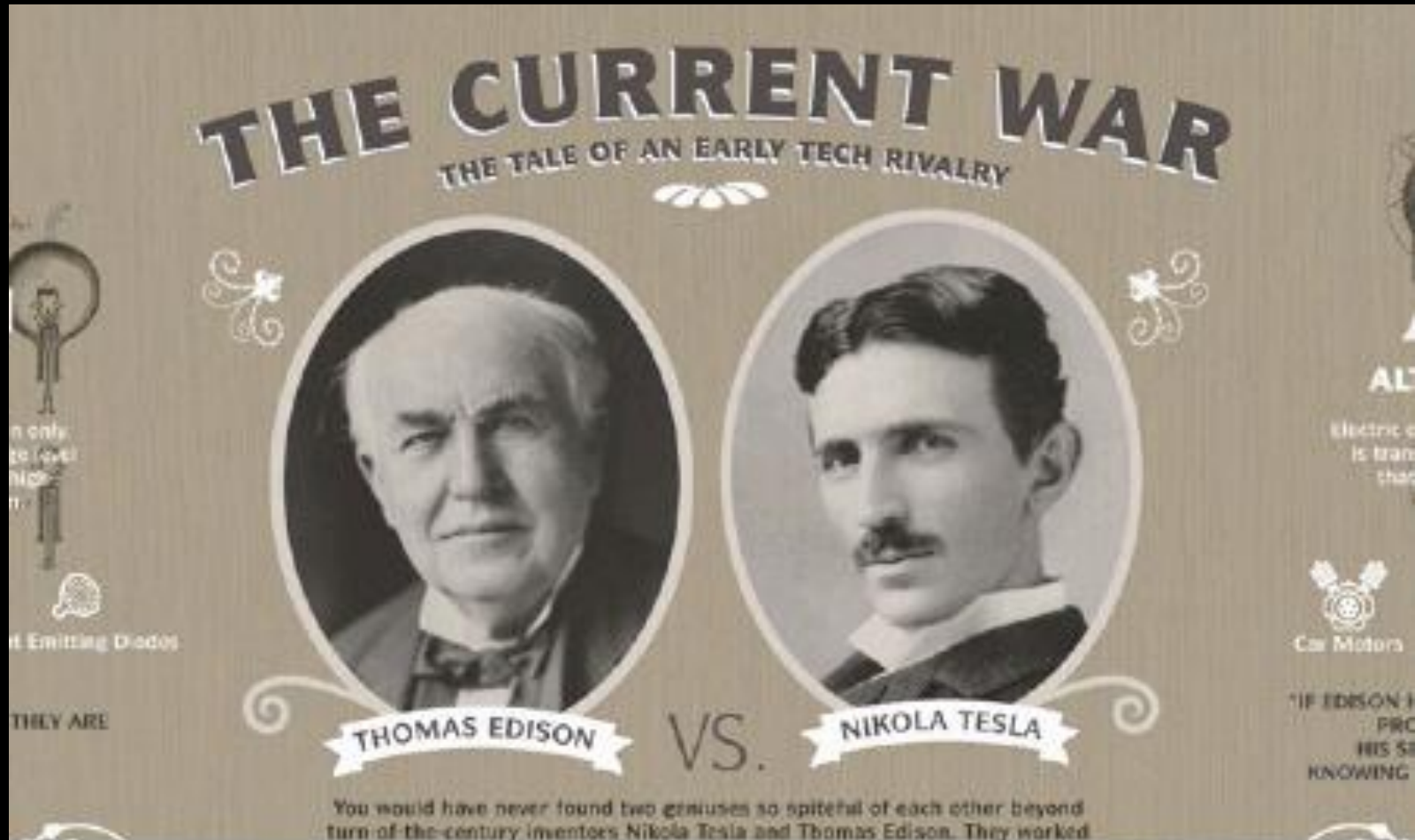

LAUNCH INFOGRAPHIC

Let's transfer those advantages to PV

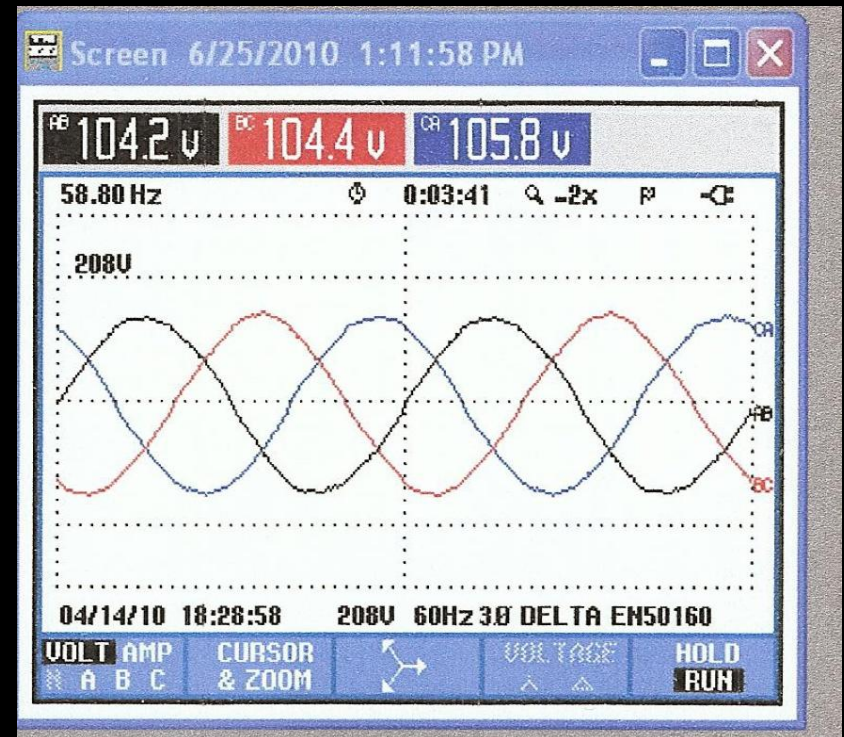

Decentralized Electronics

■ Advantages

- LCOE over life of system
- Simplicity of installation
- Safety
- Wiring Loss Reduction
- Maintenance Cost Reduction

■ Requirements

- Reliability = survivability
- No single point of failure
- FRU for bankability
- Power Quality (THD)

■ Promises for the near future

- SMART grid features

3 Phase AC at the Panel

- **Advantages at the panel level**
 - **Energy Harvesting** = MPPT at the Panel
 - Improvements range from 5 – 15% (?)
 - Significant for localized shading - row to row; localized dirt
 - **Safety:** 600 HV DC hazard (NEC requirements)
 - Concern during design, installation and repair
 - Ongoing concern about DC to DC arcing
 - Examples WW of rare but documented problems
 - Not on financiers or insurers radar screen yet
 - **Parallel vs Series**
 - No more Christmas light effect
 - **Hot Spot Suppression**
 - MPPT searches right – no cell in reverse bias
 - Safety and survivability

Balanced 3 phase AC

Scalable Parallel 3-Phase Delta Power Bus

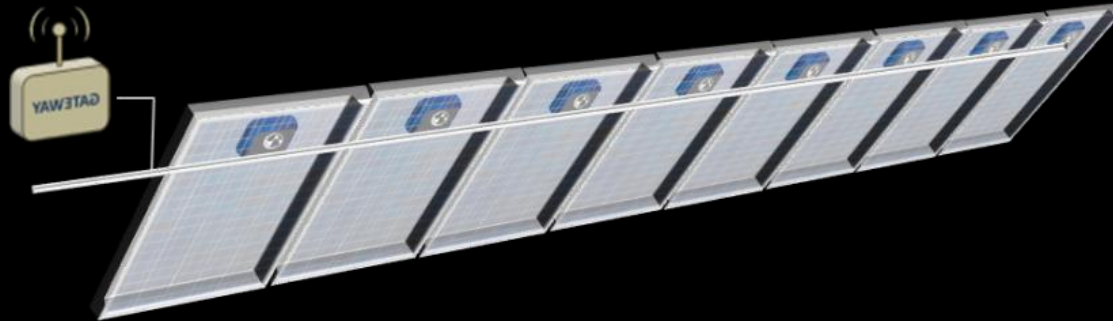

Inherently Balanced 3-Phase Power Output

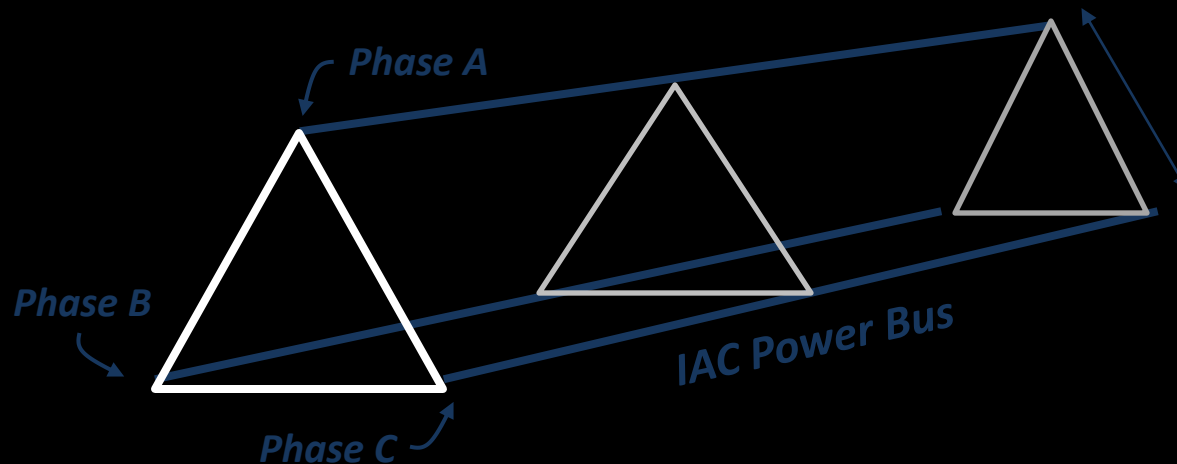

Plant Design

- **Simplicity**
 - String length
 - Panel matching = no issue
 - Install or replacement
 - Powerline Communications
 - No additional comms trenching required
- **Utility scale cluster design + transformers**
 - Simplified – repetitive design
 - Minimize DC home runs
 - Accessibility
- **Wiring losses**
 - AC vs DC losses

System Simplification Opportunity

Conventional Central Inverter System

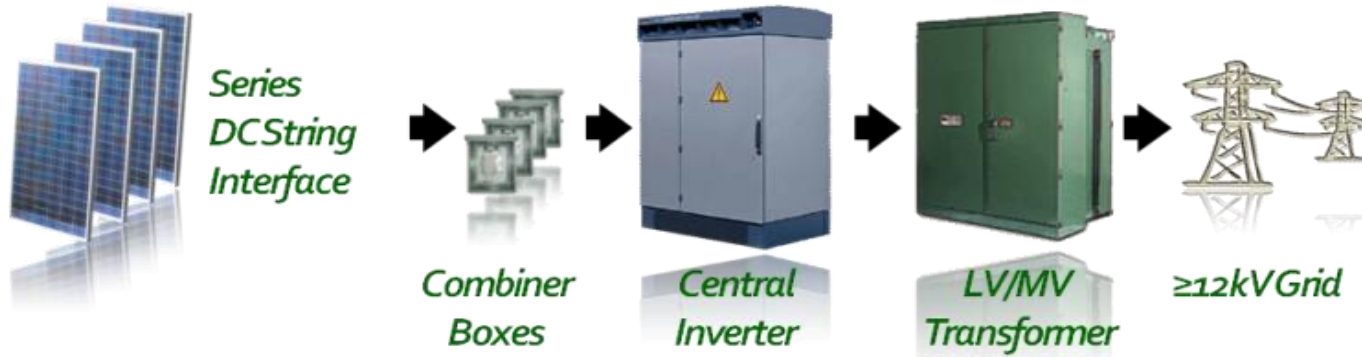

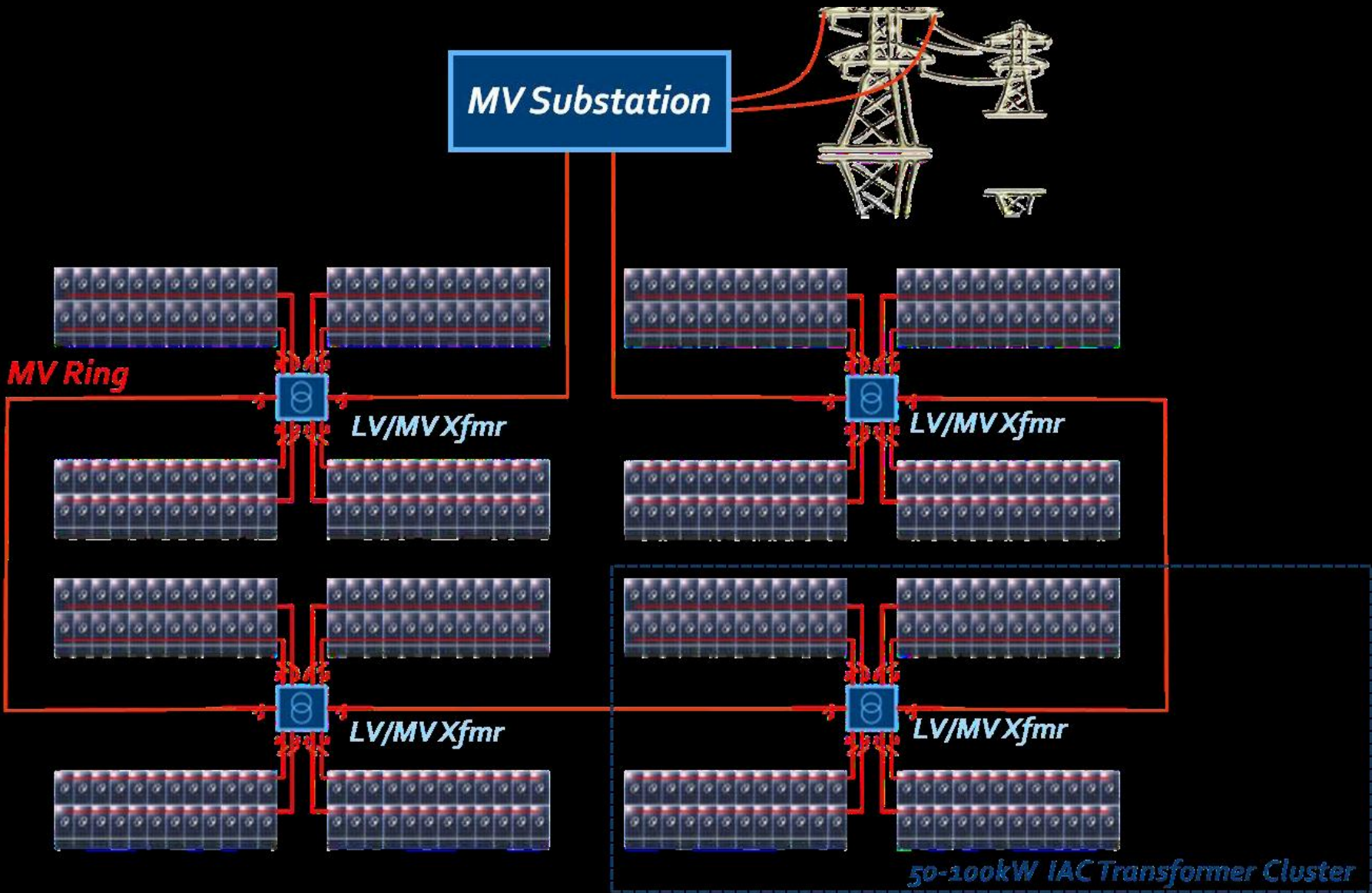

Operations & Maintenance

- **High(er) Plant Availability Possible**
 - No single point of failure
 - No routine downtime/replacement for electronics
 - Reduced COO (cost of ownership)
- **Leverage panel monitoring**
 - *Managed* maintenance vs routine truck rolls
 - Instead of time warranty => energy warranty
 - Localized diagnostic capability
 - Efficient repair/replacement
- **Net: 8 – 10% more energy over life**

SMART Grid Potential

- Low THD ($< 1.5\%$)
- Power Factor Control
- Reactive Power Management
- Low Voltage Ride Through
- Frequency Ride Through

Opportunity for Cost Reduction

- Consumer Electronics (Style) Device for Industrial Use
- Standard Semiconductor ICs
 - Easily cost reduced with volume (30 – 50%)
- Film or Ceramic Caps
- RoHS compliant
- Match coeff of thermal expansion
- Remember ATS 3 is still working
 - 1967 -> 2000

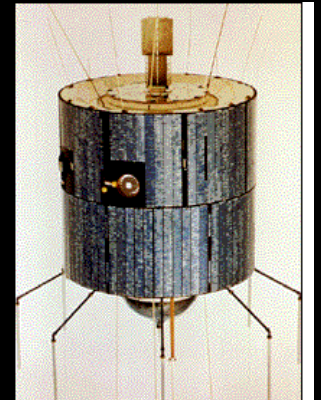

Conclusions

- Distributed electronics can afford considerable cost reductions
 - First Cost and total cost of ownership
- Increased Energy Harvesting
- Opportunities for standardization and simplification of design

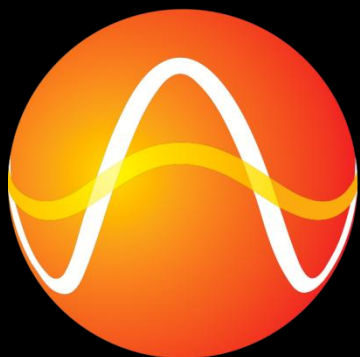

array
converter